



## SANITARY CENTRIFUGAL PUMPS

### CR series



HYGIENE



BIOTECHNOLOGY



INDUSTRIAL

Centrifugal pumps incorporating a special auger type screw shaped impeller, which is ideal for the gentle handling of very delicate fluids and large soft solids in suspension. Wetted parts in investment cast CF-3M 1.4404 / AISI 316L stainless steel, electro-chemically polished to ensure the perfect surface finish. Separate IEC standard motor. Stainless steel shroud and adjustable feet on request. The clamp casing and seal design allows quick disassembly for inspection, cleaning and maintenance. It also enables the delivery port to be rotated to any position for easy installation.

*Delicate handling without clogging.*  
The CR Series has been designed for very gentle handling of sensitive media at extremely low flow velocities.

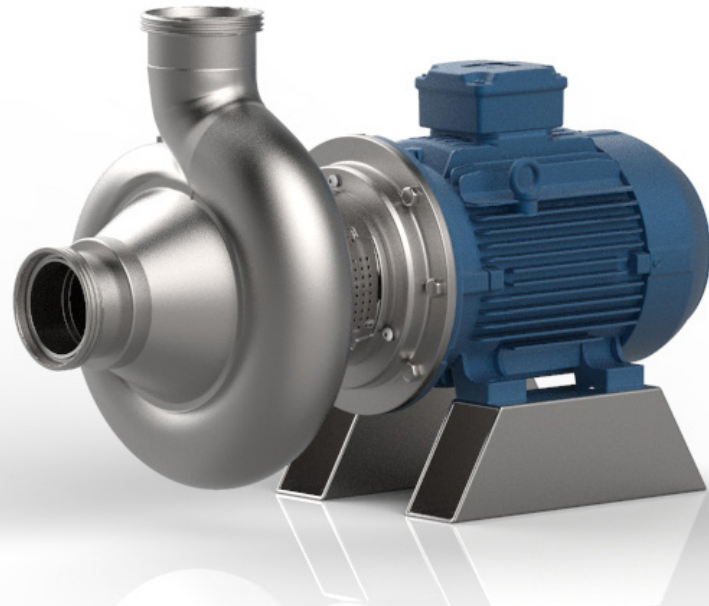

The screw shape impeller combines the properties of a centrifugal pump with the delicate characteristics of a positive displacement pump. The ability to handle high solids products in an extremely gentle way makes CR Series pumps ideal for food processing: Fruit and vegetable handling, soups and sauces, cereals, fish transportation, food pastes, oil, wine recirculation.

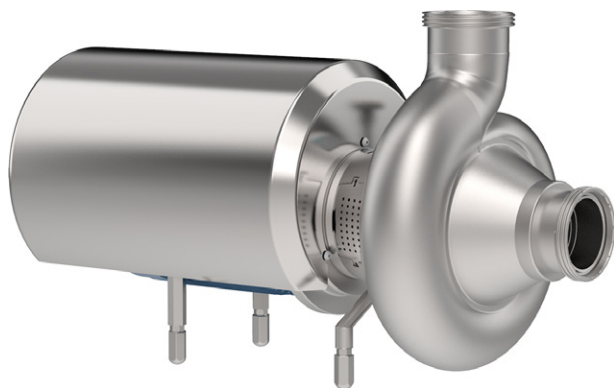

CR pump with shroud

#### TECHNICAL DATA

Flow rates up to 150 m<sup>3</sup>/h  
Heads up to 20 m  
Maximum operating pressure 10 bar up to 100°C  
Temperature range -10°+ +100°

#### Mechanical seals:

With seats to EN 12756, ISO 3069 standards.  
Single internal mechanical seal  
Single external mechanical seal  
Double flushed mechanical seal

#### Elastomers (FDA Regulation (EC) No. 1935/2004):

Nitrile (NBR)  
Ethylene propylene (EPDM)  
Fluorocarbon seal (FPM - FKM)  
FEP  
FFPM - FFKM  
Silicone

#### Connections:

DIN - SMS - IDF - BS / RJT - DS - CLAMP and  
EN1092-1 PN16 flanges suitable for all international standards.

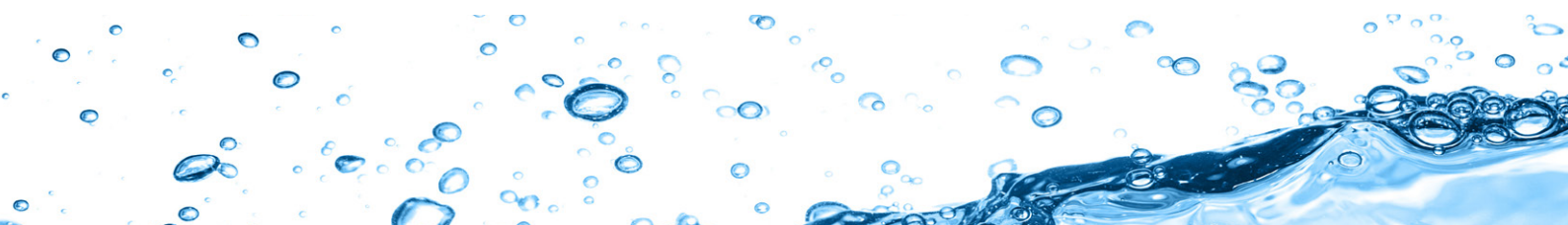

## GENERAL DIAGRAMS

(Performance applies to H<sub>2</sub>O at 20 °C, 1013 mbar, Data not binding)

<b>POMPA TIPO</b> Pump type		<b>CR 65</b>			n <b>920/1110</b> giri / min r. p. m.	
GIRANTE — Impeller						
TIPO Type	N° di pale n° of vanes	Pass. sferico max. sphere	Ø max max. diameter	Ø min min. diameter	Bocche tipo Ports type	Bocca aspir. Suction port DN <b>65</b>
APERTA	1 Elica	33 mm	156 mm	— mm	DIN 11851	Bocca mand. Discharge port DN <b>65</b>
CARATTERISTICHE DI FUNZIONAMENTO CON ACQUA PULITA A 20°C - PESO SPECIFICO 1 (kg/dm <sup>3</sup> ) Curves show performance with clear water at 70°F - Specific gravity 1 (kg/dm <sup>3</sup> )						

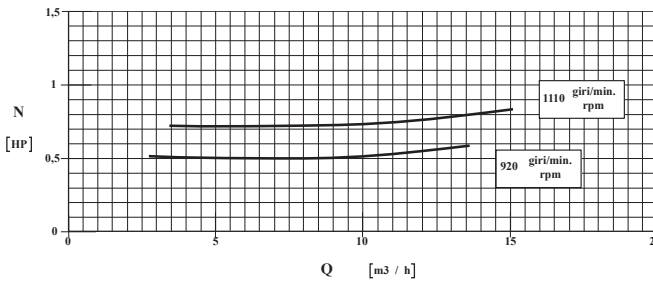
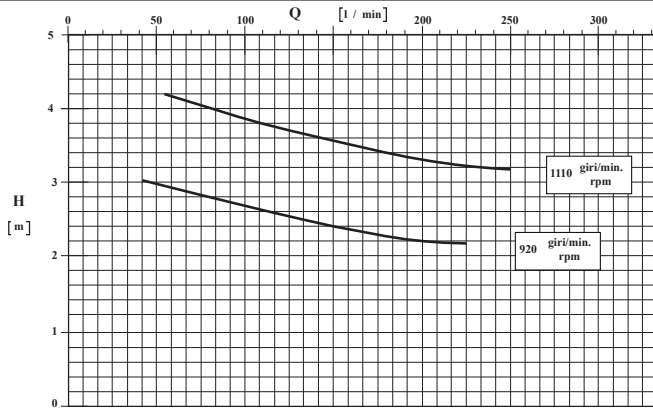

<b>POMPA TIPO</b> Pump type		<b>CR 80</b>			n <b>960/1150</b> giri / min r. p. m.	
GIRANTE — Impeller						
TIPO Type	N° di pale n° of vanes	Pass. sferico max. sphere	Ø max max. diameter	Ø min min. diameter	Bocche tipo Ports type	Bocca aspir. Suction port DN <b>80</b>
APERTA	1 Elica	45 mm	178 mm	— mm	DIN 11851	Bocca mand. Discharge port DN <b>80</b>
CARATTERISTICHE DI FUNZIONAMENTO CON ACQUA PULITA A 20°C - PESO SPECIFICO 1 (kg/dm <sup>3</sup> ) Curves show performance with clear water at 70°F - Specific gravity 1 (kg/dm <sup>3</sup> )						

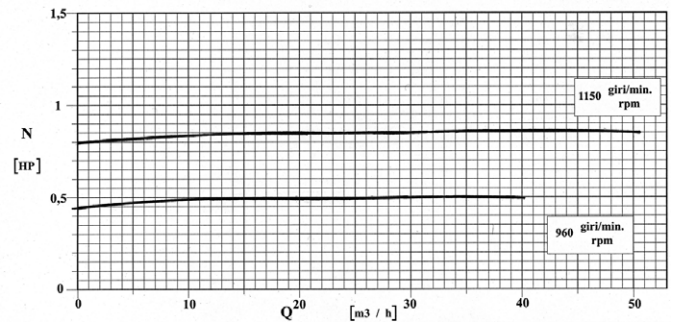
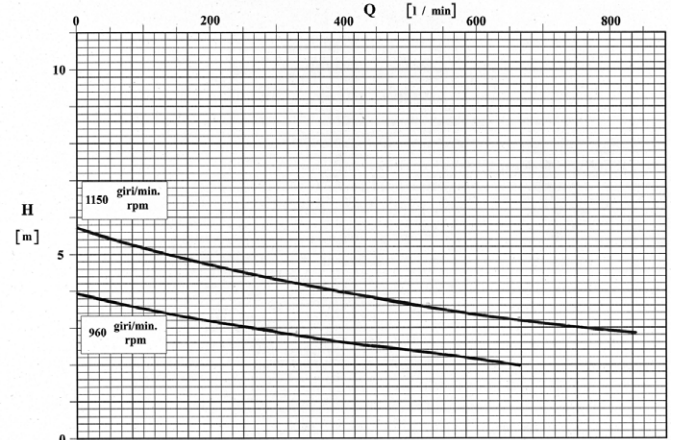

<b>POMPA TIPO</b> Pump type		<b>CR 100</b>			n <b>960/1150</b> giri / min r. p. m.	
GIRANTE — Impeller						
TIPO Type	N° di pale n° of vanes	Pass. sferico max. sphere	Ø max max. diameter	Ø min min. diameter	Bocche tipo Ports type	Bocca aspir. Suction port DN <b>100</b>
APERTA	1 Elica	58 mm	210 mm	— mm	DIN 11851	Bocca mand. Discharge port DN <b>100</b>
CARATTERISTICHE DI FUNZIONAMENTO CON ACQUA PULITA A 20°C - PESO SPECIFICO 1 (kg/dm <sup>3</sup> ) Curves show performance with clear water at 70°F - Specific gravity 1 (kg/dm <sup>3</sup> )						

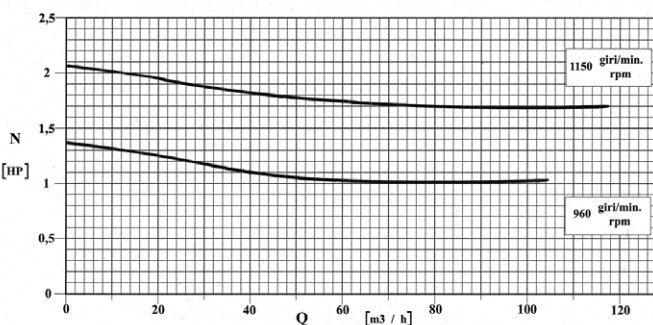
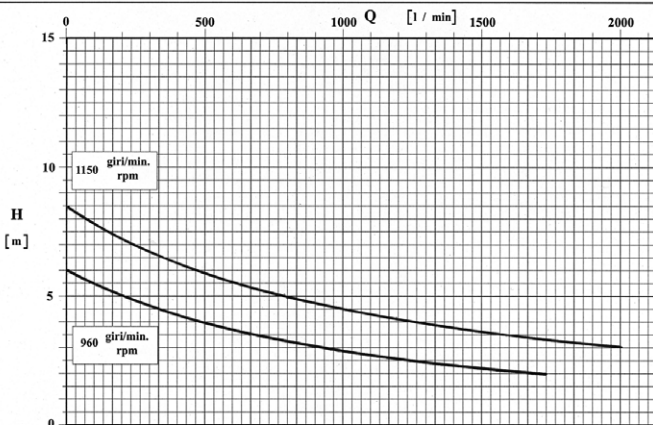

<b>POMPA TIPO</b> Pump type		<b>CR 125</b>			n <b>960/1150</b> giri / min r. p. m.	
GIRANTE — Impeller						
TIPO Type	N° di pale n° of vanes	Pass. sferico max. sphere	Ø max max. diameter	Ø min min. diameter	Bocche tipo Ports type	Bocca aspir. Suction port DN <b>125</b>
APERTA	1 Elica	63 mm	260 mm	— mm	DIN 11851	Bocca mand. Discharge port DN <b>125</b>
CARATTERISTICHE DI FUNZIONAMENTO CON ACQUA PULITA A 20°C - PESO SPECIFICO 1 (kg/dm <sup>3</sup> ) Curves show performance with clear water at 70°F - Specific gravity 1 (kg/dm <sup>3</sup> )						

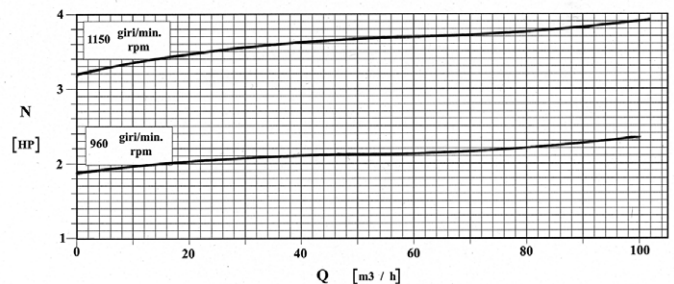
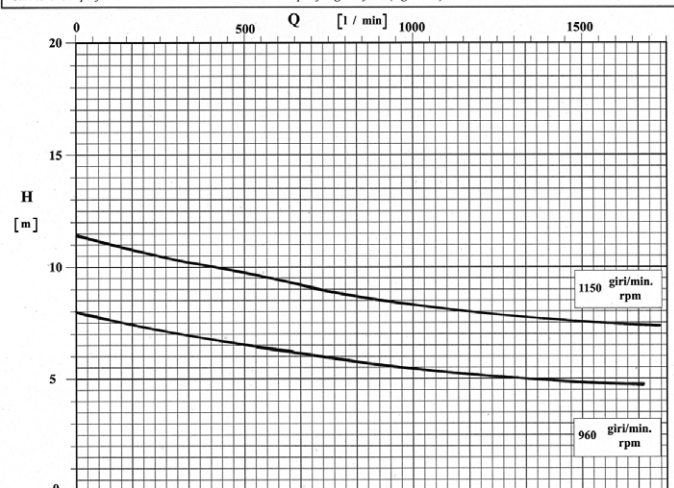

<b>POMPA TIPO</b>		<b>CR 65</b>			<b>n 1400/1750</b>		giri / min r. p. m.	
GIRANTE — Impeller								
TIPO Type	N° di pale n° of vanes	Pass. sferico max. sphere	Ø max max. diameter	Ø min min. diameter	Bocche tipo Ports type	Bocca aspir. Suction port	DN 65	
APERTA	1 Elica	33 mm	156 mm	---	DIN 11851	Bocca mand. Discharge port	DN 65	
CARATTERISTICHE DI FUNZIONAMENTO CON ACQUA PULITA A 20°C - PESO SPECIFICO 1 (kg/dm <sup>3</sup> ) Curves show performance with clear water at 70°F - Specific gravity 1 (kg/dm <sup>3</sup> )								

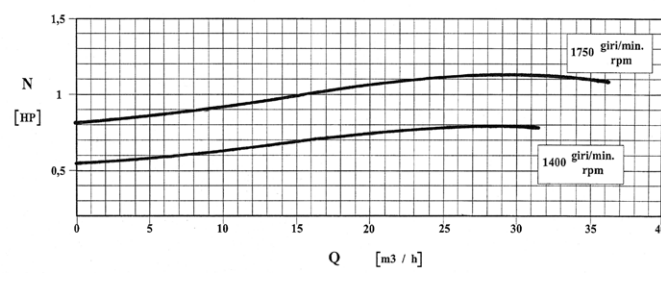
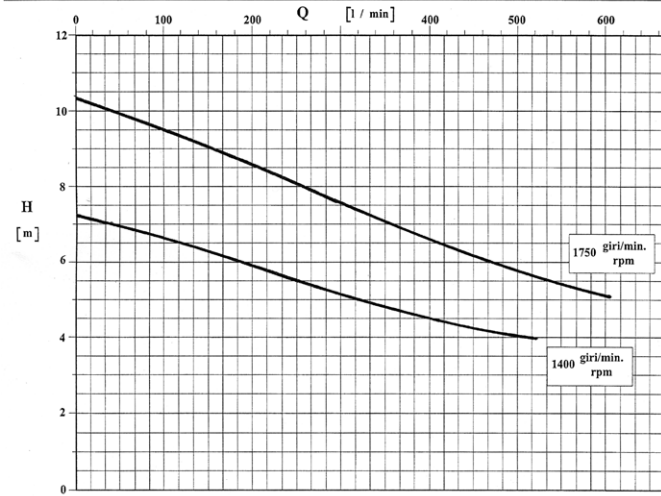

<b>POMPA TIPO</b>		<b>CR 80</b>			<b>n 1450/1750</b>		giri / min r. p. m.	
GIRANTE — Impeller								
TIPO Type	N° di pale n° of vanes	Pass. sferico max. sphere	Ø max max. diameter	Ø min min. diameter	Bocche tipo Ports type	Bocca aspir. Suction port	DN 80	
APERTA	1 Elica	45 mm	178 mm	---	DIN 11851	Bocca mand. Discharge port	DN 80	
CARATTERISTICHE DI FUNZIONAMENTO CON ACQUA PULITA A 20°C - PESO SPECIFICO 1 (kg/dm <sup>3</sup> ) Curves show performance with clear water at 70°F - Specific gravity 1 (kg/dm <sup>3</sup> )								

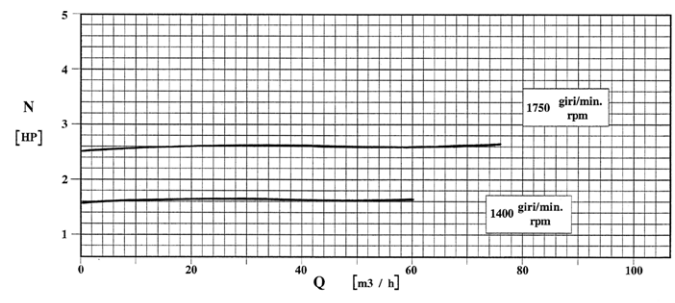
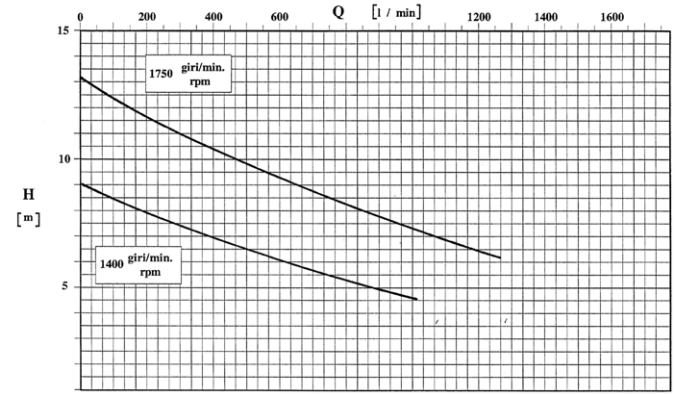

<b>POMPA TIPO</b>		<b>CR 100</b>			<b>n 1450/1750</b>		giri / min r. p. m.	
GIRANTE — Impeller								
TIPO Type	N° di pale n° of vanes	Pass. sferico max. sphere	Ø max max. diameter	Ø min min. diameter	Bocche tipo Ports type	Bocca aspir. Suction port	DN 100	
APERTA	1 Elica	58 mm	210 mm	---	DIN 11851	Bocca mand. Discharge port	DN 100	
CARATTERISTICHE DI FUNZIONAMENTO CON ACQUA PULITA A 20°C - PESO SPECIFICO 1 (kg/dm <sup>3</sup> ) Curves show performance with clear water at 70°F - Specific gravity 1 (kg/dm <sup>3</sup> )								

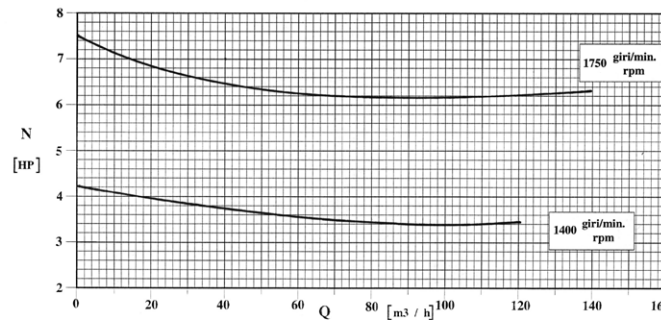
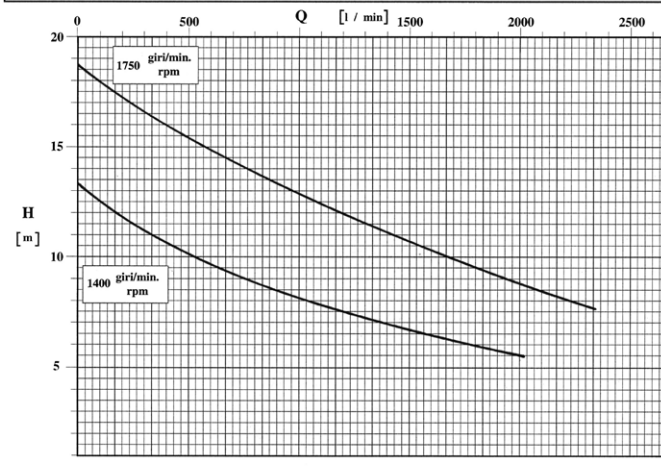

<b>POMPA TIPO</b>		<b>CR 125</b>			<b>n 1450/1750</b>		giri / min r. p. m.	
GIRANTE — Impeller								
TIPO Type	N° di pale n° of vanes	Pass. sferico max. sphere	Ø max max. diameter	Ø min min. diameter	Bocche tipo Ports type	Bocca aspir. Suction port	DN 125	
APERTA	1 Elica	63 mm	260 mm	---	DIN 11851	Bocca mand. Discharge port	DN 125	
CARATTERISTICHE DI FUNZIONAMENTO CON ACQUA PULITA A 20°C - PESO SPECIFICO 1 (kg/dm <sup>3</sup> ) Curves show performance with clear water at 70°F - Specific gravity 1 (kg/dm <sup>3</sup> )								

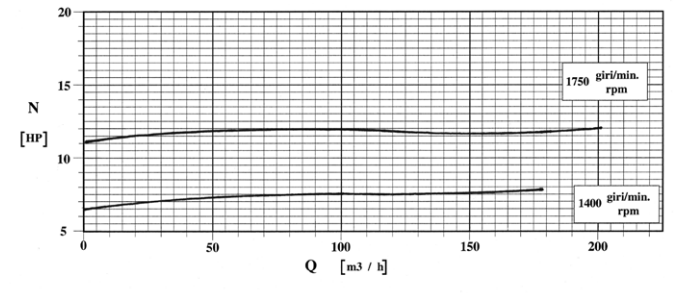
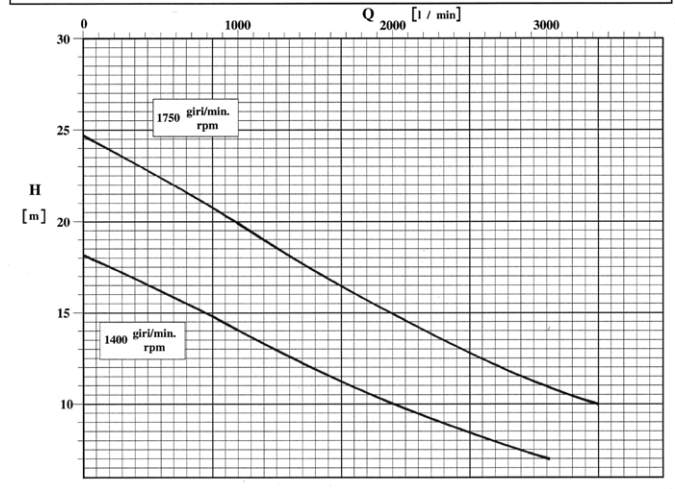

## OVERALL DIMENSIONS

Dimensions not binding - DN = DIN 11851 male threaded connections, with standard IEC/EN motors

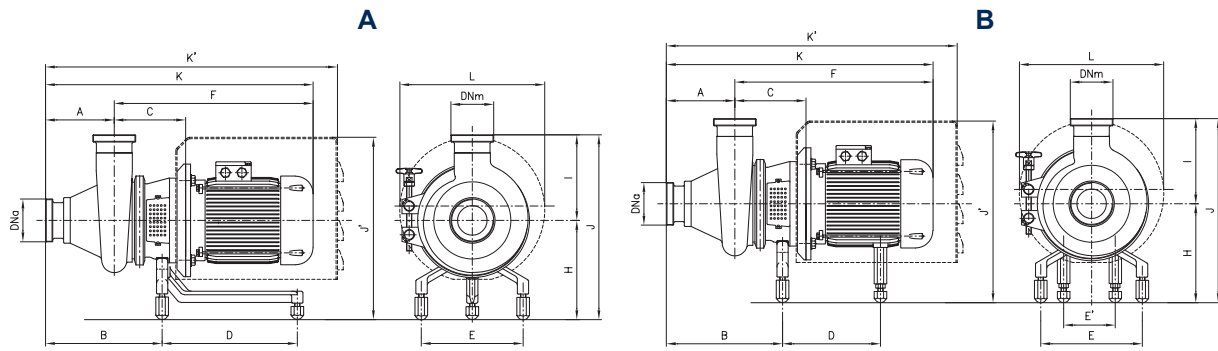

A = motors from 0,55 kW to 4 kW

Pump type	1450 rpm	kW	DNa	DNm	A	B	C	D	E	E'	F	H	K	K'	I	J	J'	L
CR 65		0,55	65	65	151	257	158	230	225	-	392	208	543	657	190	398	374	302
	0,75																	
	1,1																	
	1,5																	
CR 80	1,1	80	80	181	297	168	300	225	-	452	213	632	699	245	458	379	302	
	1,5																	
	2,2																	
	3																	
CR 100	2,2	100	100	205	337	202	300	225	-	536	238	741	824	296	534	443	330	
	3																	
	4																	

B = motors from 5,5 kW to 15 kW

Pump type	1450 rpm	kW	DNa	DNm	A	B	C	D	E	E'	F	H	K	K'	I	J	J'	L
CR 100		5,5	100	100	205	325	204	283	225	180	576	238	784	848	294	526	460	370
	7,5																	
	11																	
	15																	
CR 125	5,5	125	125	232	370	230	292	225	180	604	238	836	900	346	584	501	430	
	7,5																	
	11																	
	15																	

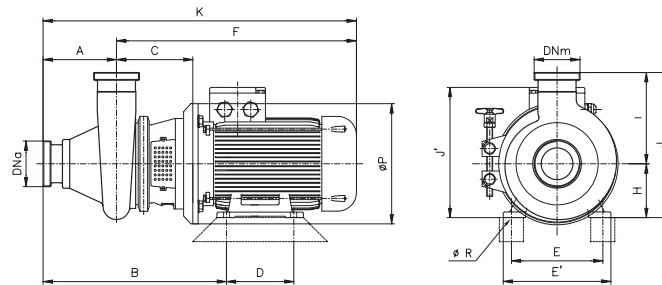

Pump type	1450 rpm	kW	DNa	DNm	A	B	C	D	E	E'	F	H	K	I	J	J'	ØP	ØR
CR 65		0,55	65	65	151	360	158	100	125	150	392	80	543	190	270	200	200	10
	0,75																	
	1,1																	
	1,5																	
CR 80	1,1	80	80	181	406	168	140	125	140	165	452	90	632	245	335	218	200	10
	1,5																	
	2,2																	
	3																	
CR 100	2,2	100	100	205	477	202	140	190	240	515	112	720	294	406	331	250	12	
	3																	
	4																	
	5,5																	
CR 125	5,5	125	125	232	550	230	140	216	256	604	132	836	346	478	404	300	12	
	7,5																	
	11																	
	15																	



C.S.F. Inox S.p.A. Strada per Bibbiano, 7 - 42027 Montecchio E. (RE) - ITALY EU

Ph +39.0522.869911 r.a. - Fx +39.0522.865454 - italia@csf.it - www.csf.it

Export Department • Commercial Étranger • Comercial Extranjero

Ph +39.0522.869922 - Fx +39.0522.869841 - export@csf.it - www.csf.it



All the instructions, data and representations (in whatever way executed) listed in this publication are indicative and do not binding. C.S.F. does not stand surely or undertake any obligation for the utilisation of this document and for the information contained. In particular, it does not guarantee against omissions or errors of the data and drawings here indicated. Notice that the technical specifications, information and representations in this document are merely indicative and approximate. C.S.F. INOX reserves the right at any moment and without notice to modify the data, drawings and information indicated in this document.