



Pneumatically operated 2/2-way angle seat valve CLASSIC

- Stainless steel or gunmetal housing with threaded, clamped or welded connection
- Long service life
- High flow rate
- Robust actuators with modular accessory program



Product variants described in the data sheet may differ from the product presentation and description.

Can be combined with



Type 8644

Remote Process Actuation Control System AirLINE



Type 8640

Modular valve island for pneumatics



Type 8697

Pneumatic control for decentralised automation of ELEMENT process valves



Type 7012

Direct-acting 3/2-way plunger valve



Type 6014

Plunger valve 3/2-way direct-acting



Type 8840

Modular process valve cluster – distribution and collecting

Type description

The externally piloted angle seat valve is operated with a single or double-acting piston actuator. The actuator is available in two different materials, depending on the ambient temperature. High flow rates are attained with the virtually straight flow path. The reliable self-adjusting packing gland provides high sealing integrity. These maintenance-free and robust valves can be retrofitted with a comprehensive range of accessories for position indication, stroke limitation or manual override.

Table of contents

1. General technical data	4
2. Product versions	5
2.1. Gunmetal body with PA actuator	5
2.2. Stainless steel body with PA actuator.....	5
2.3. Stainless steel body with PPS actuator.....	5
3. Circuit functions	6
4. Approvals	6
5. Materials	7
5.1. Chemical Resistance Chart – Bürkert resistApp.....	7
5.2. Material specifications	7
6. Dimensions	8
6.1. Actuator	8
Angle seat valve Type 2000 and valve system On/Off CLASSIC Type 8801-YA.....	8
6.2. Body with threaded connection	9
6.3. Body with welded connection.....	10
6.4. Body with clamp connection	11
7. Performance specifications	12
7.1. Fluidic data	12
Overview of fluidic data for flow below seat (for gases, steam and liquids).....	12
Pilot pressure diagram with flow direction below seat (control function B, seat seal PTFE).....	13
Overview of fluidic data with flow above seat (for gases and steam).....	14
Pilot pressure diagram with flow direction above seat (control function A, seat seal PTFE).....	15
7.2. Operating limits.....	16
Operating limits for medium temperature and operating pressure	16
Operating limits for ambient and medium temperature	17
Operating limits for optional versions	17
8. Product accessories	18
9. Networking and combination with other Bürkert products	19
10. Ordering information	20
10.1. Bürkert eShop – Easy ordering and quick delivery.....	20
10.2. Bürkert product filter	20
10.3. Ordering chart threaded connection.....	21
Valve with flow direction below seat	21
Valve with flow direction above seat.....	22
10.4. Ordering chart welded connection	23
Valve with flow direction below seat	23
Valve with flow direction above seat.....	24
10.5. Ordering chart clamp connection	25
Valve with flow direction below seat	25
Valve with flow direction above seat.....	26

10.6. Ordering chart accessories..... 27
Accessories for 3/2-way pilot valves with banjo bolts..... 27

1. General technical data

Product properties	
Dimensions	More detailed information can be found in the chapter “6. Dimensions” on page 8.
Material	More detailed information can be found in the chapter “5. Materials” on page 7.
Design	Angle seat valve
Port connection size	DN 10...DN 80, NPS ¾...NPS 3
Safety setting in case of power failure	Normally closed (control function A), normally open (control function B)
Flow direction	Flow to open (below seat), Flow to close (above seat)
Performance data	
Operating pressure	0...25 bar(g), Vacuum up to -0.9 bar (g) (option), see “7.1. Fluidic data” on page 12
Nominal pressure	PN 25 (DIN EN 1333), Class 150 (DIN EN 1759)
Pilot pressure	2...10 bar(g), see “7.1. Fluidic data” on page 12
K _v value	3.8...140 m ³ /h
Media data	
Medium	Steam, water, neutral gases, alcohol, oils, fuels, hydraulic fluids, salt solution, alkali solutions, organic solvents, for fuel gases of category I, II and III acc. to Gas Appliances Regulation (EU) 2016/426 and oxygen
Medium temperature	-40...230 °C, see “7.2. Operating limits” on page 16
Viscosity	Max. 600 mm ² /s
Control medium	Air, neutral gases
Process/Port connection & communication	
Port Connections ¹⁾	
Threaded connection	G (DIN ISO 228 - 1) NPT (ASME B1.20.1) Rc (ISO 7 - 1)
Welded connection	DIN EN ISO 1127 / ISO 4200 / DIN11866 B DIN 11850 2 / DIN 11866 A ASME BPE / DIN 11866 C SMS 3008
Clamp connection	DIN 32676 B (pipe ISO 4200) DIN 32676 A (pipe DIN 11850 2) ASME BPE
Pilot air port	
Actuator size Ø 40(C)	Thread G ⅝
Actuator size Ø 50(D) ... 125(H)	Thread G ¼
Approvals and certificates	
Conformity	Food contact 1935/2004(EG), FDA Drinking water Pressure equipment directive Gas Appliances Regulation Machinery Directive
Approval	Explosion proof ATEX / IECex
Material certificate	2.2, 3.1
Environment and installation	
Ambient temperature	-40...140 °C see “2. Product versions” on page 5
Degree of protection	IP67
Installation position	As required, preferably with actuator upright

1.) Others on request

2. Product versions



2.1. Gunmetal body with PA actuator

Product properties	
Nominal diameter	DN 10...DN 65, NPS ¾...NPS 2 ½
Performance data	
Operating pressure	0...16 bar(g), vacuum up to -0.9 bar (g) (option), see "7.1. Fluidic data" on page 12
Maximum pilot pressure	
Actuator size 40(C), 50(D), 63(E), 80(F)	10 bar(g)
Actuator size 100(G), 125(H)	7 bar(g)
Media data	
Medium temperature	-40...180 °C
Product connection	
Port connection	Threaded connection
Environment and installation	
Ambient temperature	-40...60 °C (see "7.2. Operating limits" on page 16)



2.2. Stainless steel body with PA actuator

Product properties	
Nominal diameter	DN 10...DN 80, NPS ¾...NPS 3
Performance data	
Operating pressure	0...25 bar(g), vacuum up to -0.9 bar (g) (option), see "7.1. Fluidic data" on page 12
Maximum pilot pressure	
Actuator size 40(C), 50(D), 63(E), 80(F)	10 bar(g)
Actuator size 100(G), 125(H)	7 bar(g)
Media data	
Medium temperature	-40...185 °C
Product connection	
Port connection	Threaded, welded or clamp connection
Environment and installation	
Ambient temperature	-40...60 °C (see "7.2. Operating limits" on page 16)



2.3. Stainless steel body with PPS actuator

Product properties	
Nominal diameter	DN 10...DN 80, NPS ¾...NPS 3
Performance data	
Operating pressure	0...25 bar(g), vacuum up to -0.9 bar(g) (option), see "7.1. Fluidic data" on page 12
Maximum pilot pressure	
Actuator size 40(C), 50(D), 63(E), 80(F)	10 bar(g)
Actuator size 100(G), 125 (H)	7 bar(g)
Media data	
Medium temperature	-40...230 °C
Product connection	
Port connection	Threaded, welded or clamp connection
Environment and installation	
Ambient temperature	-40...140 °C (continuous operation up to 130 °C) (see "7.2. Operating limits" on page 16)

3. Circuit functions

⚠ CAUTION
Risk of damage due to bursting pipes and bursting equipment when the flow is above the seat.
In the case of liquid mediums, water hammer can occur causing pipes and the device to burst.
 Do not use valves with flow above the seat for liquid mediums..

Control function (CF)	Description	
Flow direction below seat for liquids, steam and gases		
	CF: A, pneumatically operated on/off valve 2/2-way Flow direction below seat Normally closed by spring force	
	CF: B, pneumatically operated on/off valve 2/2-way Flow direction below seat Normally open by spring force	
Flow direction above seat for steam and gases		
	CF: A, pneumatically operated on/off valve 2/2-way Flow direction above seat Normally closed by spring force	

4. Approvals

Approvals	Description
	Food contact Materials in contact with the medium conform to EC Regulation 1935/2004 (option) Materials in contact with the medium conform to FDA (option)
	Drinking water Suitable for use with drinking water for medium temperatures up to 85 °C in accordance with the Drinking Water Ordinance §17 and the assessment principles of the Federal Environment Agency (option).
	Oxygen Suitable for use with gaseous oxygen with medium temperature up to 60 °C and operating pressure up to 20 bar(g) (option)
	Explosion proof As category 2 device suitable for zone 1/21 and zone 2/22 (option)
	ATEX: II 2G Ex h IIC T4 Gb II 2D Ex h IIIC T135 °C Db IECEX: Ex h IIC T4 Gb Ex h IIIC T135 °C Db
	Fuel gases Approval according to the European Gas Appliance Regulation (EU) 2016/426, DVGW DIN EN 161 and DIN EN 16678, Class A or Class D, suitable for medium temperature 0...+160 °C, ambient temperature -10...+60 °C and operating pressure 0...16 bar(g) (option)
	Safety requirements Evaluation of functional safety according to IEC 61508 (on request)

DTS 1000444947 EN Version: R Status: RL (released | freigegeben | valide) printed: 09.03.2023

5. Materials

5.1. Chemical Resistance Chart – Bürkert resistApp

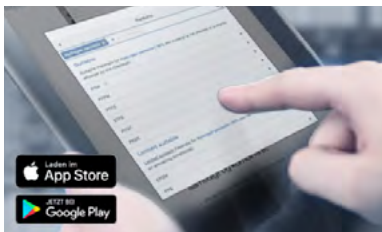

Bürkert resistApp – Chemical Resistance Chart

You want to ensure the reliability and durability of the materials in your individual application case? Verify your combination of media and materials on our website or in our resistApp.

[Start Chemical Resistance Check](#)

5.2. Material specifications

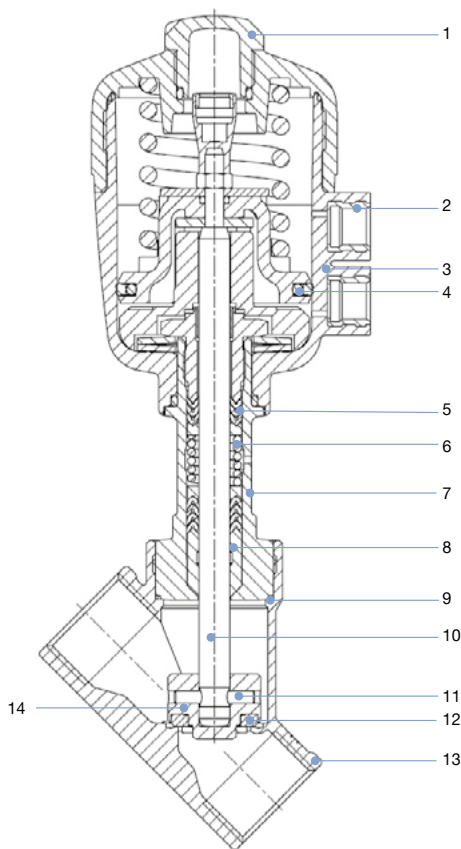

No.	Element	Material		
		Gunmetal body with PA actuator	Stainless steel with PA actuator	Stainless steel with PPS actuator
1	Transparent cover	PC	PC	PSU
2	Pilot air ports	Stainless steel 1.4305		
3	Actuator	PA	PA	PPS
4	Piston seal	NBR	NBR	FKM
5	Spindle sealing	PTFE V-Rings (filled), with spring compensation		
6	Spring	Stainless steel 1.4310		
7	Pipe ^{1.)}	Brass	Stainless steel 1.4401 Stainless steel 316L ^{2.)}	Stainless steel 1.4401 Stainless steel 316L ^{2.)}
8	Wiper	PTFE (filled), PEEK ^{3.)}		
9	Body seal	Graphite, PTFE (option)		
10	Spindle	Stainless steel 1.4401 or 1.4404		
11	Pin	Stainless steel 1.4401 or 1.4404		
12	Seat seal	PTFE, PEEK (option), NBR (option), FKM (option)		
13	Valve body	Gun metal	Stainless steel 316L/CF3M	
14	Swivel plate	Brass	Stainless steel 1.4401 or 1.4404	

1.) One piece for the actuator sizes 63 mm (E), 80 mm (F), 100 mm (G) and 125 mm (H)

2.) For the actuator sizes 63 mm (E), 80 mm (F), 100 mm (G) and 125 mm (H)

3.) For the actuator sizes 100 mm (G) and 125 mm (H)

6. Dimensions

6.1. Actuator

Angle seat valve Type 2000 and valve system On/Off CLASSIC Type 8801-YA

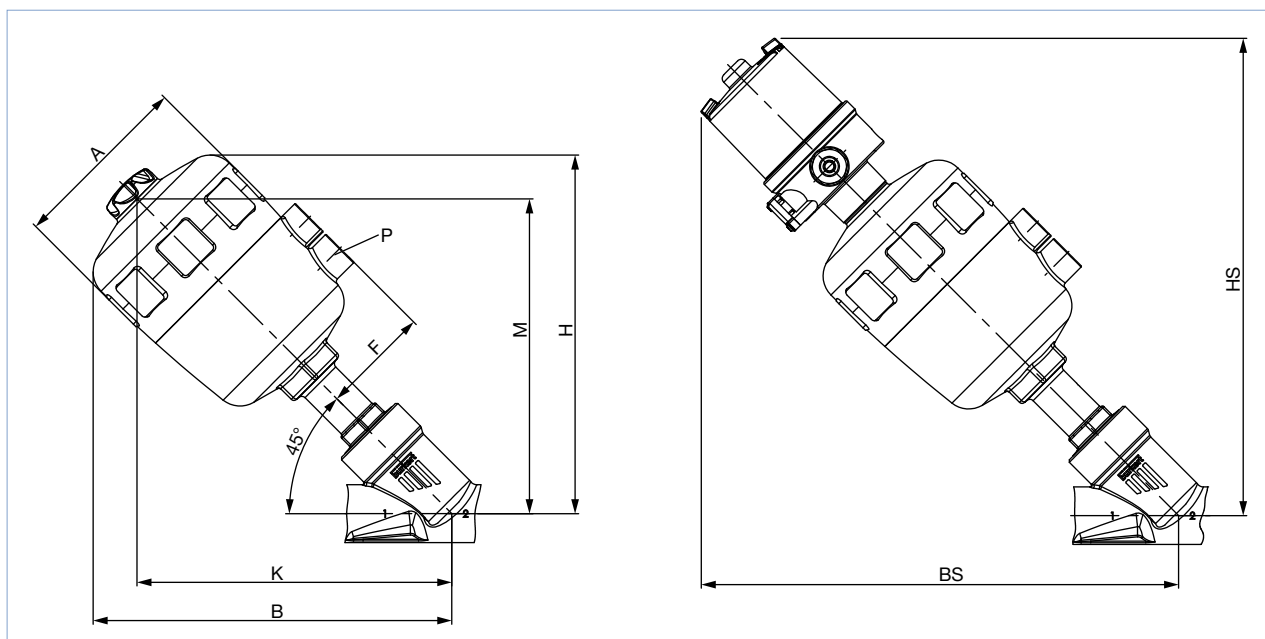

Nominal diameter (pipe)		Actuator size Ø	Ø A	B / H ^{1.)}	K / M ^{1.)}	P	BS / HS ^{1.)}
DN	NPS		[mm]	[mm]	[mm]	[inch]	[mm]
10	3/8	40(C)	53	127	110	G 1/8	198
		50(D)	64	145	129	G 1/4	216
		63(E)	80	177	158	G 1/4	246
15	1/2	40(C)	53	127	110	G 1/8	198
		50(D)	64	145	129	G 1/4	216
		63(E)	80	177	158	G 1/4	246
20	3/4	40(C)	53	130	113	G 1/8	201
		50(D)	64	150	133	G 1/4	207
		63(E)	80	174	155	G 1/4	243
		80(F)	101	195	171	G 1/4	259
25	1	50(D)	64	152	136	G 1/4	223
		63(E)	80	178	159	G 1/4	242
		80(F)	101	195	171	G 1/4	259
32	1 1/4	63(E)	80	188	169	G 1/4	257
		80(F)	101	209	185	G 1/4	273
		100(G)	127	262	232	G 1/4	320
40	1 1/2	63(E)	80	191	172	G 1/4	260
		80(F)	101	213	188	G 1/4	277
		100(G)	127	251	221	G 1/4	309
		125(H)	158	291	254	G 1/4	342
50	2	63(E)	80	209	190	G 1/4	278
		80(F)	101	230	206	G 1/4	294
		100(G)	127	277	247	G 1/4	335
		125(H)	158	306	269	G 1/4	357
65	2 1/2	80(F)	101	242	218	G 1/4	306
		100(G)	127	290	260	G 1/4	348
		125(H)	158	319	282	G 1/4	370
80	3	125(H)	158	339	301	G 1/4	390

1.) Dimensions for B, H, K, M, HS and BS are maximum dimensions and can be up to 6 mm smaller depending on the nominal diameter and port connection.

6.2. Body with threaded connection

Note:

Dimensions in mm

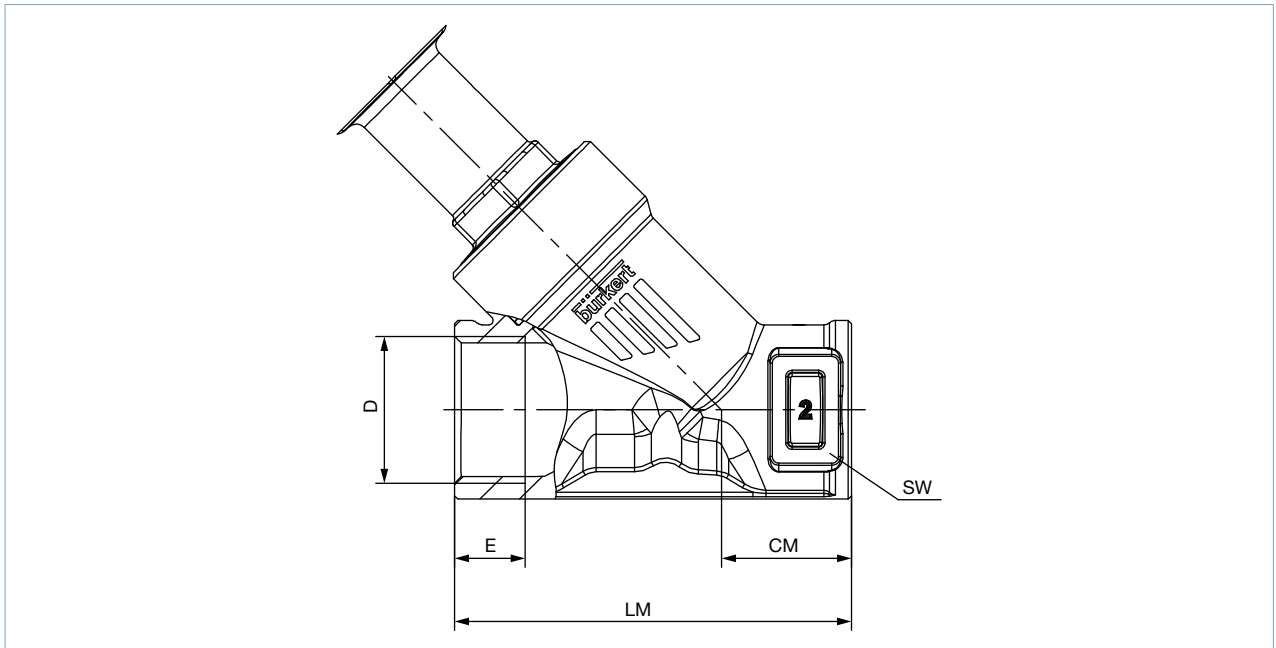

Nominal diameter (pipe)	G, Rc, NPT (EN ISO 228-1, ISO 7/1/DIN EN 10226-2, ASME B 1.20.1)					CM	LM	SW
	D	E	G	NPT	Rc			
DN	NPS							
15	½	14	13.7	13.2	24	65	27	
20	¾	16	14.0	14.5	27	75	34	
25	1	18	16.8	16.8	29.5	90	41	
32	1¼	16	17.3	19.1	36	110	50	
40	1½	18	17.3	19.1	35	120	55	
50	2	24	17.6	23.4	45	150	70	
65	2½	26	23.7	26.7	57	185	85	
80	3	28	–	–	71	220	100	

6.3. Body with welded connection

Note:

Dimensions in mm

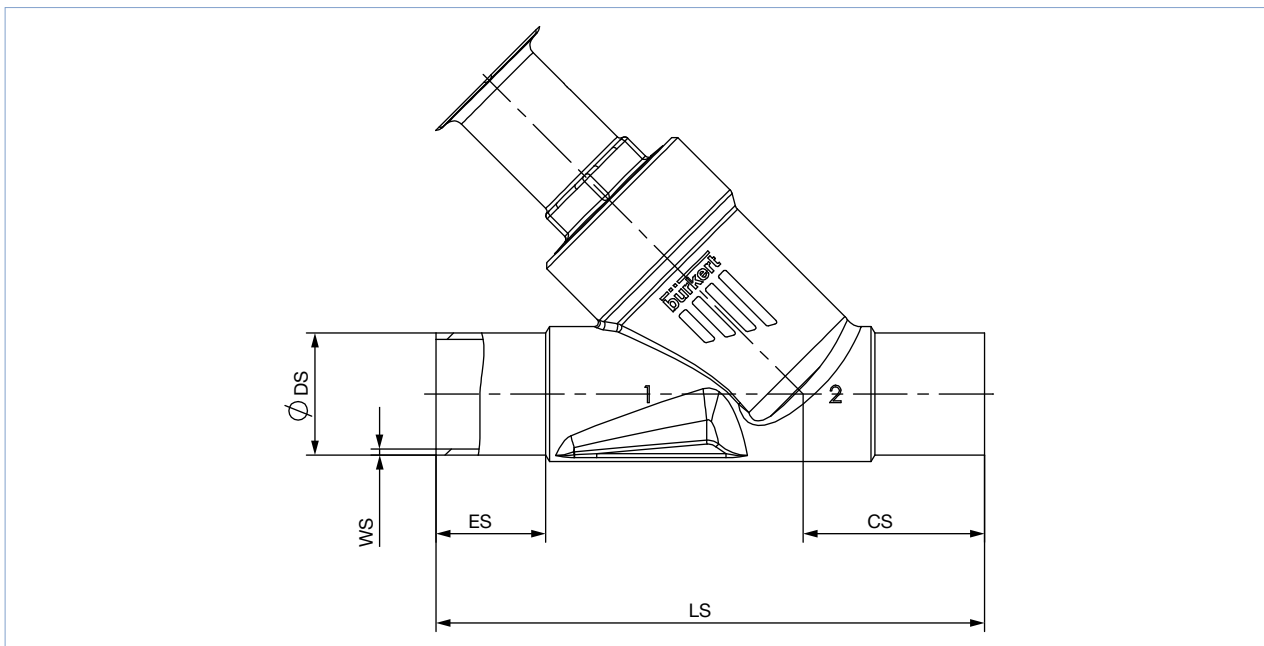

Nominal diameter (pipe)	DIN EN ISO 1127 ISO 4200 DIN 11866 B					DIN 11850 2 DIN 11866 A				
	DN	ES	CS	LS	ØDS	WS	ES	CS	LS	ØDS
15	19	34	100	21.3	1.6	19	34	100	19	1.5
20	20	39	115	26.9	1.6	20	39	115	23	1.5
25	26	43	130	33.7	2.0	26	43	130	29	1.5
32	26	45	145	42.4	2.0	26	45	145	35	1.5
40	26	49	160	48.3	2.0	26	49	160	41	1.5
50	26	50	175	60.3	2.0	26	50	175	53	1.5
65	26	50	210	76.1	2.3	26	50	210	70	2

Nominal diameter (pipe)	ASME BPE DIN 11866 C				
NPS	ES	CS	LS	ØDS	WS
½	30	46	135	12.7	1.65
¾	30	52	145	19.05	1.65
1	30	51	152	25.4	1.65
1½	30	60	182	38.1	1.65
2	30	64	210	50.8	1.65
2½	26	56	230	63.5	1.65

DTS 1000444947 EN Version: R Status: RL (released | freigegeben | validé) printed: 09.03.2023

6.4. Body with clamp connection

Note:
Dimensions in mm

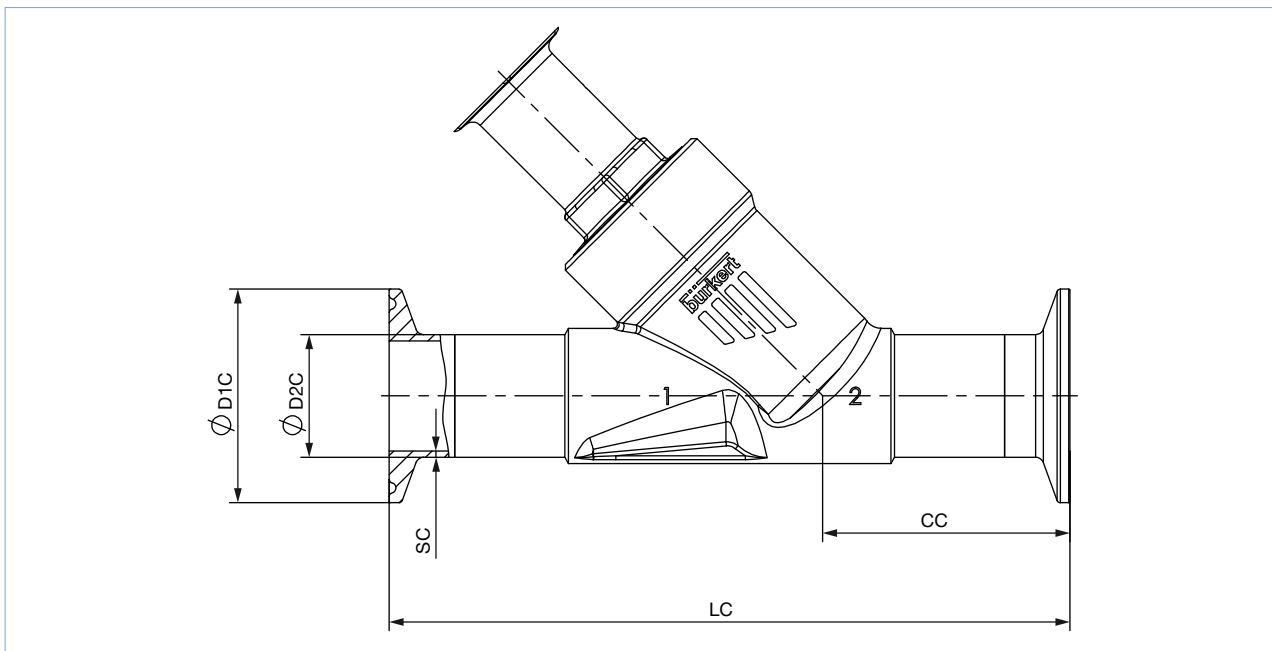

Nominal diameter (pipe)	Clamp: DIN 32676 B					Clamp: DIN 32676 A (DN 15 similar DIN 32676 B)				
	Pipe: EN ISO 1127 1 ISO 4200 DIN 11866 B					Pipe: DIN 11850 2 DIN 11866 A				
DN	LC	CC	ØD1 C	ØD2 C	SC	LC	CC	ØD1 C	ØD2 C	SC
15	156	49.0	50.5	21.3	1.6	130	49.5	34.0	19	1.5
20	150	56.5	50.5	26.9	1.6	150	57.0	34.0	23	1.5
25	160	58.0	50.5	33.7	2.0	160	58.5	50.5	29	1.5
32	200	57.5	50.5	42.4	2.0	180	58.0	50.5	35	1.5
40	200	69.0	64.0	48.3	2.0	200	69.5	50.5	41	1.5
50	230	77.5	77.5	60.3	2.6	230	78.0	64.0	53	1.5

Nominal diameter (pipe)	Clamp: ASME BPE				
	Pipe: ASME BPE DIN 11866 C				
NPS	LC	CC	ØD1 C	ØD2 C	SC
½	130	49.0	25.0	12.7	1.65
¾	150	56.5	25.0	19.05	1.65
1	160	58.0	50.5	25.4	1.65
1½	200	69.0	50.5	38.1	1.65
2	230	77.5	64.0	50.8	1.65

DTS 1000444947 EN Version: R Status: RL (released | freigegeben | validé) printed: 09.03.2023

7. Performance specifications

7.1. Fluidic data

Overview of fluidic data for flow below seat (for gases, steam and liquids)

Note:

- K_v value [m^3/h]: Measured with water at +20 °C, 1 bar pressure at valve inlet and free outlet
- C_v value [GMP(US)] = $K_v \times 1.156$

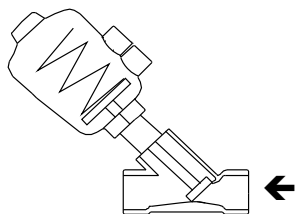

Nominal diameter		Actuator size Ø	K_v -value	Pilot pressure min.	Operating pressure max.		
					CF: A	CF: A	CF: B
		Seat seal			CF: A	CF: A	CF: B
		PTFE			PTFE	PEEK	PTFE
DN	NPS	[mm]	[m^3/h]	[bar(g)]	[bar(g)]	[bar(g)]	[bar(g)]
10	3/8	40(C)	3.7	4	15	-	16
		50(D)	4.0	4.1	16	-	16
		63(E)	4.3	4.5	25 ^{1.)}	25 ^{1.)}	25 ^{1.)}
15	1/2	40(C)	3.8	4	15	-	16
		50(D)	4.2	4.1	16	-	16
		63(E)	4.5	4.5	25 ^{1.)}	25 ^{1.)}	25 ^{1.)}
20	3/4	40(C)	7	4	6.5	-	16
		50(D)	8.5	4.1	11	-	16
		63(E)	9	4.5	20 ^{1.)}	16	25 ^{1.)}
		80(F)	9	5	25 ^{1.)}	25 ^{1.)}	-
25	1	50(D)	10	4.1	5.2	-	16
		63(E)	18	4.5	11	-	25 ^{1.)}
		80(F)	18	5	25 ^{1.)}	21 ^{1.)}	25 ^{1.)}
32	1 1/4	63(E)	25	4.5	6	-	25 ^{1.)}
		80(F)	27	5	14	-	25 ^{1.)}
		125(H)	28	3.2	25 ^{1.)}	25 ^{1.)}	-
40	1 1/2	63(E)	35	4.5	4	-	24 ^{1.)}
		80(F)	38	5	9	-	25 ^{1.)}
		100(G)	40	4.4	12.5	-	25 ^{1.)}
		125(H)	40	4.1	25 ^{1.)}	25 ^{1.)}	-
50	2	63(E)	49	4.5	2.5	-	13
		80(F)	52	5	5	-	25 ^{1.)} (20 ^{2.)})
		100(G)	55	4.4	7.2	-	25 ^{1.)} (20 ^{2.)})
		125(H)	55	5.7	24 ^{1.)} (20 ^{2.)})	20 ^{1.)}	-
65	2 1/2	80(F)	77	5	3.5	-	15
		125(H)	90	5.7	12	10	23 ^{1.)} (15 ^{2.)})
80	3	125(H)	140	5.7	7.5	-	14 (12.5 ^{2.)})

1.) Gunmetal versions are limited to max. 16 bar(g)

2.) According to pressure equipment directive 2014/68/EU for compressible fluids of group 1 (dangerous gases and vapours according to article 4, paragraph (1), c), i), first indent)

Pilot pressure diagram with flow direction below seat (control function B, seat seal PTFE)

Actuator size Ø: 40(C)

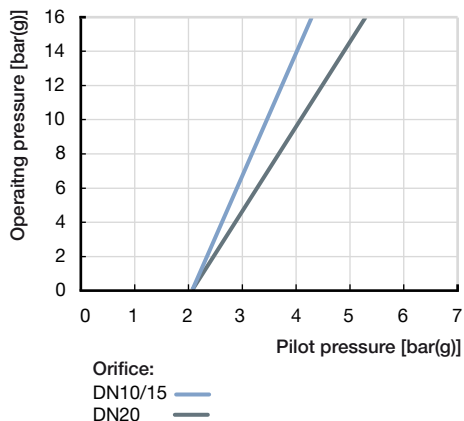

Actuator size Ø: 50(D)

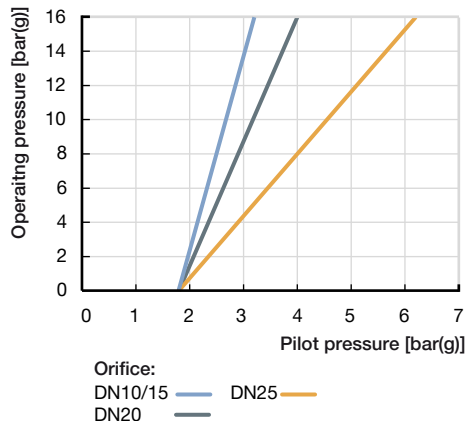

Actuator size Ø: 63(E)

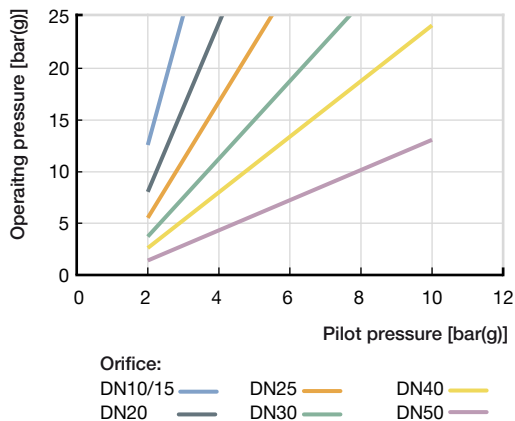

Actuator size Ø: 80(F)

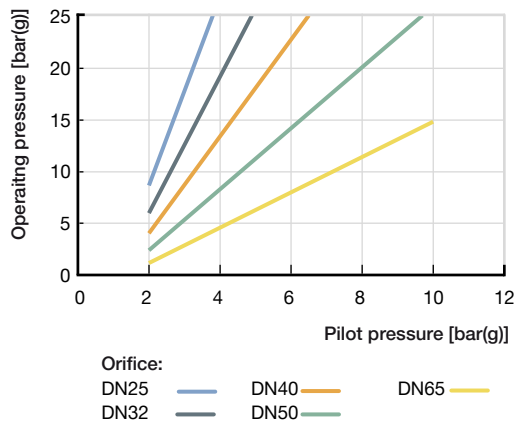

Actuator size Ø: 100(G)

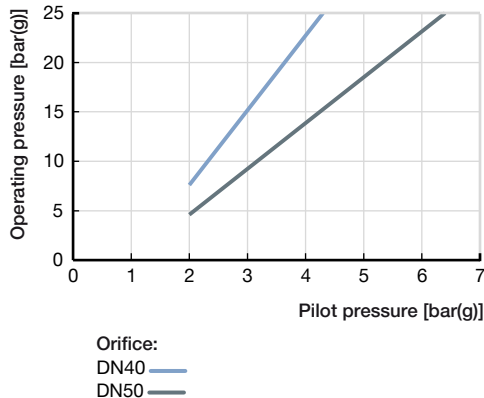

Actuator size Ø: 125(H)

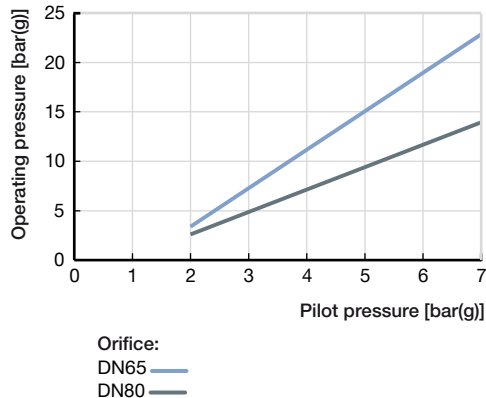

DTS 1000444947 EN Version: R Status: RL (released | freigegeben | valide) printed: 09.03.2023

Overview of fluidic data with flow above seat (for gases and steam)

⚠ CAUTION

Risk of damage due to bursting pipes and bursting equipment when the flow is above the seat.
In the case of liquid mediums, water hammer can occur causing pipes and the device to burst.

Do not use valves with flow above the seat for liquid mediums..

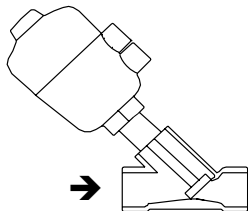

Nominal diameter		Actuator size Ø [mm]	K _v -value [m ³ /h]	Max. operating pressure	
DN	NPS			CF: A [bar(g)]	PTFE
10	3/8	40(C)	3.7	16	
		50(D)	4.0	16	
15	1/2	40(C)	3.8	16	
		50(D)	4.2	16	
20	3/4	40(C)	7	16	
		50(D)	8.5	16	
25	1	50(D)	10	16	
		63(E)	18	16	
32	1 1/4	63(E)	25	16	
40	1 1/2	63(E)	35	16	
		80(F)	38	16	
50	2	63(E)	49	16	
		80(F)	52	16	
65	2 1/2	80(F)	77	14	
		100(G)	90	15	

Pilot pressure diagram with flow direction above seat (control function A, seat seal PTFE)

Actuator size Ø: 40(C)

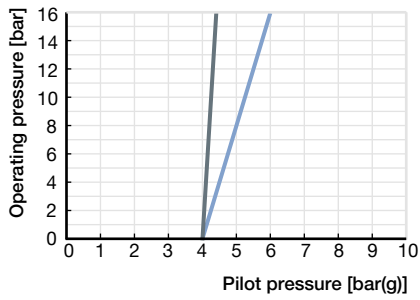

Orifice:
 DN15 —
 DN20 —

Actuator size Ø: 50(D)

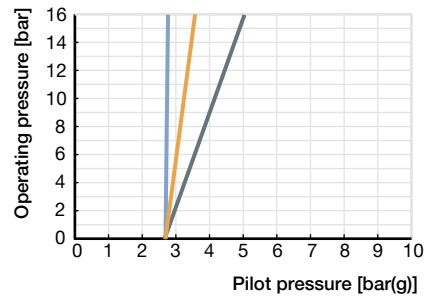

Orifice:
 DN15 —
 DN20 —
 DN25 —

Actuator size Ø: 63(E)

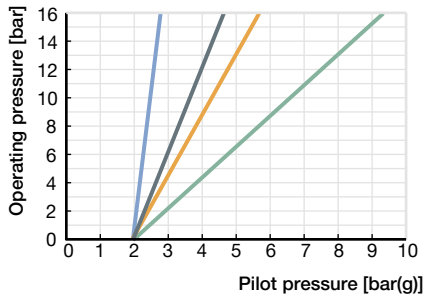

Orifice:
 DN25 — DN40 —
 DN32 — DN50 —

Actuator size Ø: 80(F)

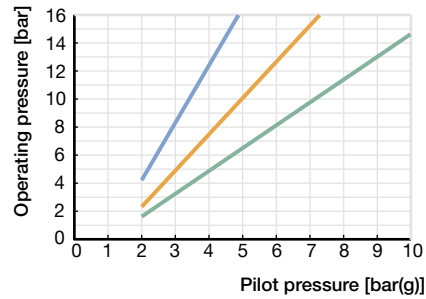

Orifice:
 DN40 —
 DN50 —
 DN65 —

Actuator size Ø: 100(G)

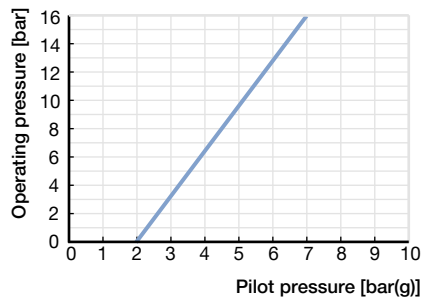

Orifice:
 DN65 —

7.2. Operating limits

Operating limits for medium temperature and operating pressure

The operating range of Bürkert process valves is in addition to the maximum operating pressures limited by the nominal pressure according to the relevant standard.

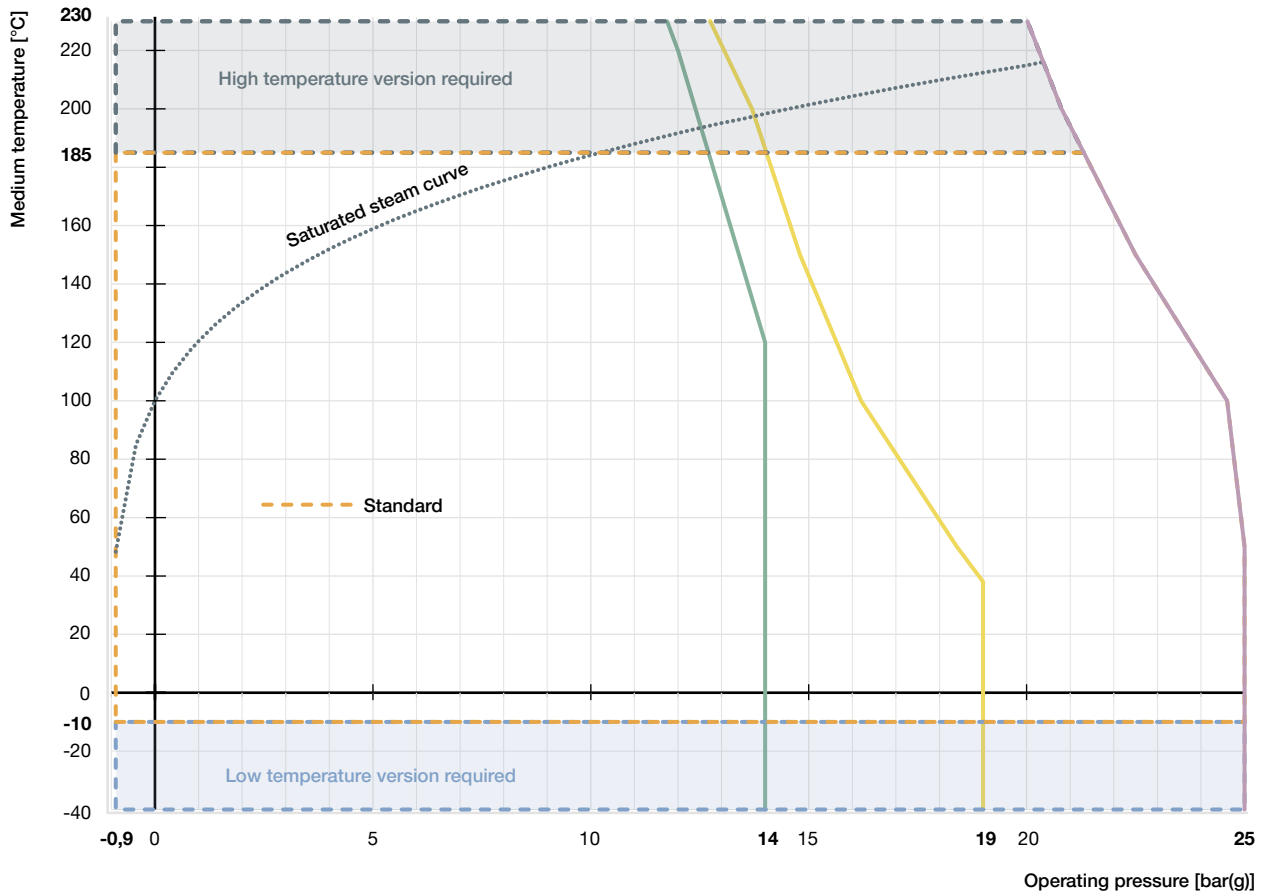

- Operating limits for PN25 acc. to DIN EN 12516-1
- Operating limits for flange 10K acc. to JIS B 2220
- Operating limits for Class 150 acc. to ASME B16.34
- ⋯ Saturated steam curve for water

Operating limits for ambient and medium temperature

Note:

For PA actuators of sizes 40, 50 and 63, the combination of maximum medium temperature and maximum ambient temperature is shown in the following diagram

Classic PA actuator

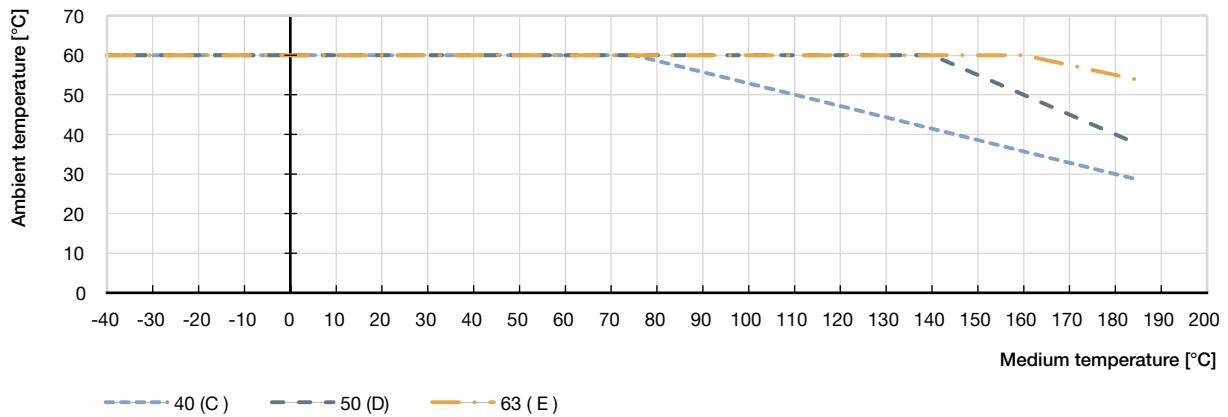

Classic PPS actuator

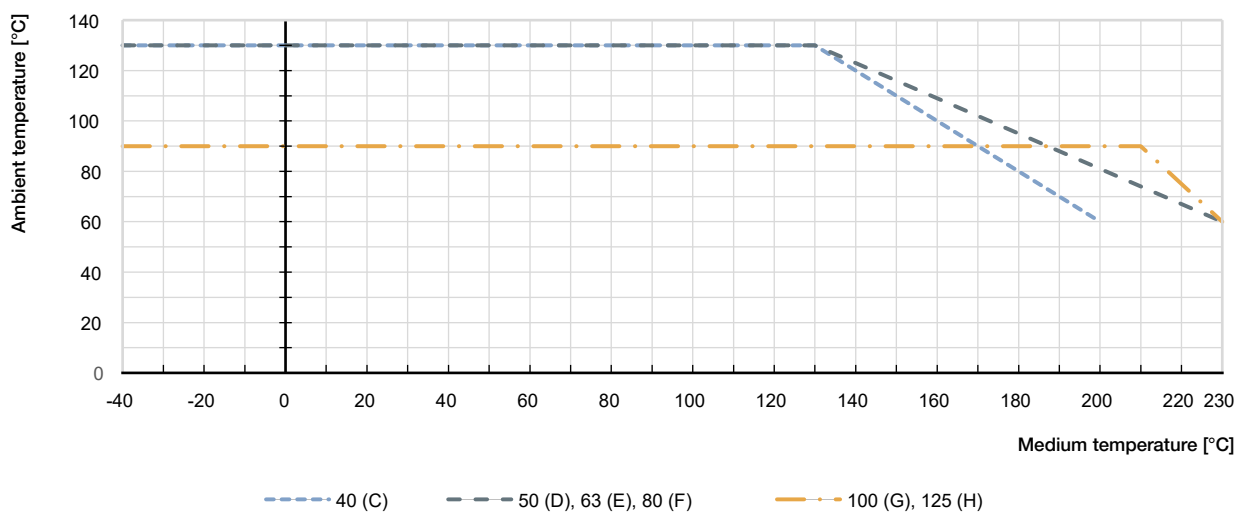

Operating limits for optional versions

High temperature version

By adapting the spindle sealing and seat seal in PEEK, this version is suitable for applications with steam, neutral gases and other heat transfer mediums up to 230 °C.

Hot water version

For applications with hot water up to 200 °C a special configuration of the spindle seal increases the lifetime significantly. It is recommended for water temperatures starting at 85 °C.

Vacuum version

Without leakage bore, this design is suitable down to -0.9 bar(g).

Low temperature version

Suitable for minimum medium temperatures down to -40 °C

8. Product accessories

Electric position feedback sensor	
Type 8697 ▶ Actuator size 40(C) ... 125(H)	Description The position feedback Type 8697 is designed for integrated mounting on CLASSIC series 20XX process valves suiting the requirements of hygienic process environment Mechanical or inductive limit switches register the position of the valve Features <ul style="list-style-type: none"> • Compact design • LED position indicator • Mechanical or inductive limit switches for end position registering • Easy to clean chemically resistant housing featuring IP65/IP67, 4X Rating • Optional intrinsically safe version acc. to ATEX Customer benefits <ul style="list-style-type: none"> • Easy and quick installation • High level of signal reliability thanks to self adjusting limit switches • Minimised space requirement in the plant piping for more flexibility in plant design
	
Adaptation for proximity switch	
Type 2XXX ▶	Description Various options for the use of inductive proximity switches are available for the actuators of the CLASSIC series: <ul style="list-style-type: none"> • Nipple • Support bracket, 1-fold • Support bracket, 2-fold
	
Plunger valve 3/2-way direct acting	
Type 7012 ▶ for actuator size Ø 40(C) ... 63(E) Type 6014 ▶ for actuator size Ø 50(D) ... 125(H)	Description For easy direct mounting to a pneumatic actuator, a banjo connection with banjo bolt is the ideal solution. An optional manual override allows fast commissioning and optimum maintenance. In conjunction with a cable plug according to DIN EN 175301 - 803 Form A or B, the valves meet protection class IP65 Features <ul style="list-style-type: none"> • High reliability • Resistant according to IP65 Customer benefits Easy and quick installation
	
Stroke limiter	
Type 2XXX ▶	Description Stroke limitations can be used to limit the minimum (min.) and maximum (max.) flow rate of the valves. Different versions are available: <ul style="list-style-type: none"> • Max. Stroke Limitation • Max. and min. stroke limitation with optical position indicator
	

9. Networking and combination with other Bürkert products

The angled seat valve Type 2000 can be combined with the feedback positioner Type 8697 to form the valve system On/Off CLASSIC Type 8801-YA.

Note:

- For the configuration of further valve systems please use the **product enquiry form** at the end of this document.
- You order two components and receive a completely assembled and tested valve.

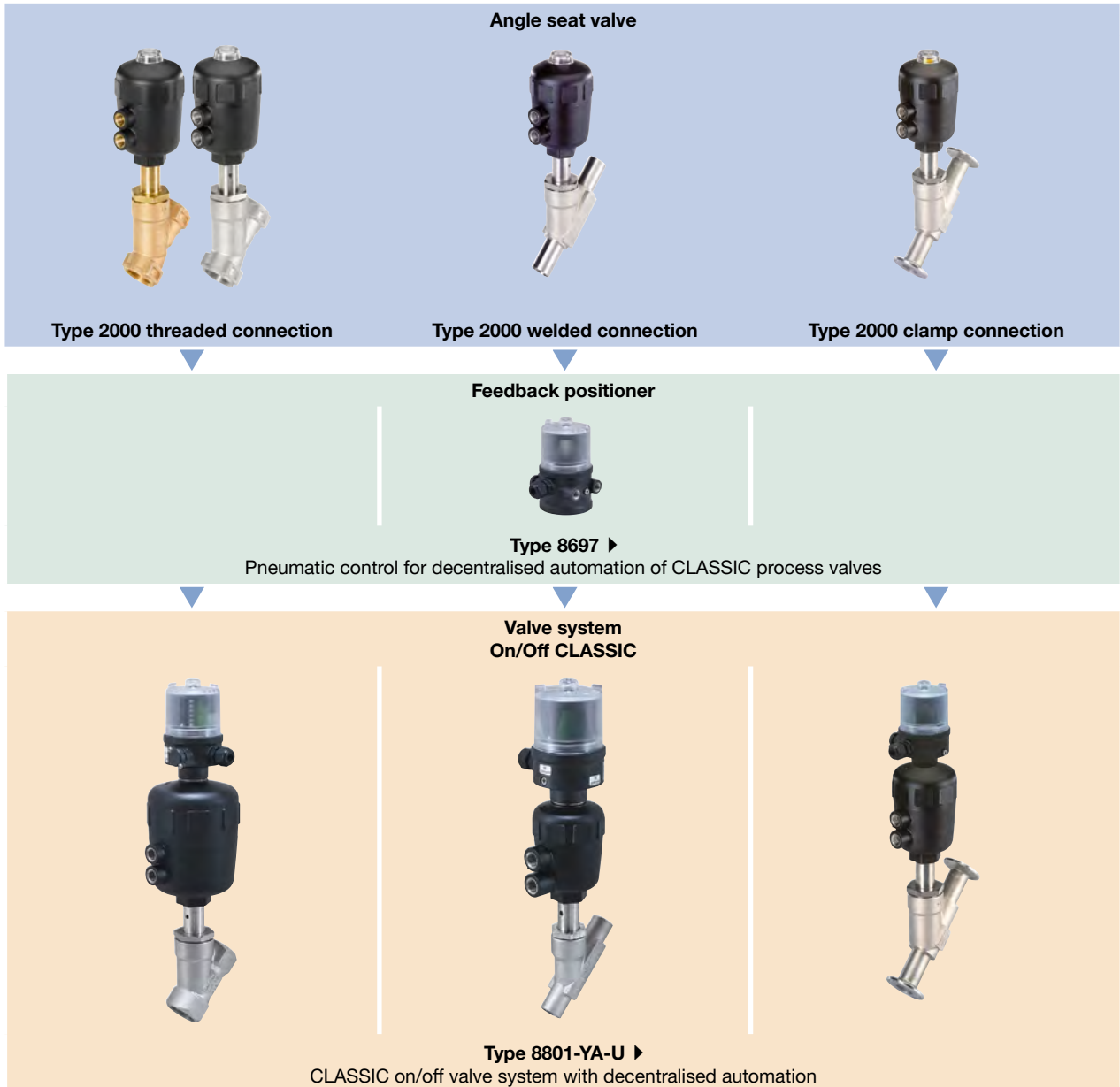

DTS 1000444947 EN Version: R Status: RL (released | freigegeben | validé) printed: 09.03.2023

10. Ordering information

10.1. Bürkert eShop – Easy ordering and quick delivery



Bürkert eShop – Easy ordering and fast delivery

You want to find your desired Bürkert product or spare part quickly and order directly? Our online shop is available for you 24/7. Sign up and enjoy all the benefits.

[Order online now](#)

10.2. Bürkert product filter



Bürkert product filter – Get quickly to the right product

You want to select products comfortably based on your technical requirements? Use the Bürkert product filter and find suitable articles for your application quickly and easily.

[Try out our product filter](#)

10.3. Ordering chart threaded connection

Valve with flow direction below seat

Control function	Nominal diameter	Actuator size Ø	K _v value	Pilot pressure min.	Operating pressure max.	Article no.	Operating pressure max.	Article no.	
	NPS	[mm]	[m ³ /h]	[bar(g)]	[bar(g)]	PA actuator	[bar(g)]	PA actuator	PPS actuator
Threaded connection G (DIN ISO 228 - 1)					Gunmetal body		Stainless steel body		
CF: A, see control functions ¹⁾	3/8	40(C)	3.7	4.0	15	344651 𐀀	15	342352 𐀀	344649 𐀀
	1/2	40(C)	3.8	4.0	15	342508 𐀀	15	345487 𐀀	344645 𐀀
		50(D)	4.2	4.1	16	344665 𐀀	16	341191 𐀀	344663 𐀀
	3/4	50(D)	8.5	4.1	11	344662 𐀀	11	344660 𐀀	344659 𐀀
		63(E)	9.0	4.5	16	344654 𐀀	20	342666 𐀀	344652 𐀀
	1	63(E)	18	4.5	11	344658 𐀀	11	344656 𐀀	344655 𐀀
		80(F)	18	5.0	16	344768 𐀀	25	342693 𐀀	344822 𐀀
	1 1/4	80(F)	27	5.0	14	344680 𐀀	14	340789 𐀀	344676 𐀀
	1 1/2	80(F)	38	5.0	9	344675 𐀀	9	343142 𐀀	344673 𐀀
		125(H)	40	3.2	16	343138 𐀀	16	342695 𐀀	On request
		125(H)	40	4.1	–	–	25	344989 𐀀	On request
	2	100(G)	55.0	4.4	7.2	183193 𐀀	7.2	344381 𐀀	344382 𐀀
		125(H)	55.0	3.2	10	344411 𐀀	10	On request	On request
		125(H)	55.0	5.7	–	–	24(20 ^{3.)})	20001172 𐀀	On request
	2 1/2	125(H)	90.0	3.2	5.2	344384 𐀀	5.2	344385 𐀀	344432 𐀀
125(H)		90.0	5.7	–	–	12	On request	361565 𐀀	
3	125(H)	140	5.7	–	–	7.5	350628 𐀀	On request	
CF: B, see control functions ¹⁾	3/8	40(C)	3.7	See diagrams ²⁾	16	344510 𐀀	16	344517 𐀀	344647 𐀀
	1/2	40(C)	3.8		16	344641 𐀀	16	344642 𐀀	344643 𐀀
		50(D)	4.2		16	344672 𐀀	16	344670 𐀀	344669 𐀀
	3/4	50(D)	8.5		16	344668 𐀀	16	344667 𐀀	344666 𐀀
	1	50(D)	10		16	344685 𐀀	16	344683 𐀀	344682 𐀀
	1 1/4	63(E)	25		16	344681 𐀀	25	344687 𐀀	344686 𐀀
	1 1/2	63(E)	35		16	344698 𐀀	25	344696 𐀀	344695 𐀀
		63(E)	49.0		13	342965 𐀀	13	344386 𐀀	344433 𐀀
	2	80(F)	52		16	344412 𐀀	25(20 ^{3.)})	344413 𐀀	344459 𐀀
		80(F)	77.0		15	439038 𐀀	15	344387 𐀀	344434 𐀀
	3	125(H)	140		–	–	14(12.5 ^{3.)})	370263 𐀀	On request

1.) Further information in chapter "3. Circuit functions" on page 6

2.) See diagrams in chapter "Pilot pressure diagram with flow direction below seat (control function B, seat seal PTFE)" on page 13

3.) According to pressure equipment directive 2014/68/EU for compressible fluids of group 1 (dangerous gases and vapours according to article 4, paragraph (1), c), i), first indent)

Valve with flow direction above seat
Note:

Please see diagrams in chapter "Pilot pressure diagram with flow direction above seat (control function A, seat seal PTFE)" on page 15.

Control function	Nominal diameter	Actuator size Ø	K _v -value water	Operating pressure max.	Article no.		
	NPS	[m ³ /h]	[m ³ /h]	[bar(g)]	PA actuator	PA actuator	PPS actuator
Threaded connection G DIN ISO 228 - 1					Gunmetal body	Stainless steel body	
CF: A, see control functions ^{1.)}	3/8	40(C)	3.7	16	344782 ☒	344516 ☒	On request
	1/2	50(D)	4.2	16	344734 ☒	344761 ☒	344765 ☒
	3/4	40(C)	7.0	16	344803 ☒	344820 ☒	On request
		50(D)	8.5	16	344741 ☒	344740 ☒	344709 ☒
	1	50(D)	10.0	16	344763 ☒	344793 ☒	344827 ☒
		63(E)	18.0	16	344694 ☒	344693 ☒	344692 ☒
	1 1/4	63(E)	25.0	16	344691 ☒	344700 ☒	344699 ☒
	1 1/2	63(E)	35.0	16	344703 ☒	344702 ☒	344701 ☒
	2	63(E)	49.0	16	344383 ☒	344395 ☒	344454 ☒
		80(F)	77.0	14	344394 ☒	344396 ☒	344457 ☒
2 1/2	100(G)	90.0	15	344485 ☒	344487 ☒	On request	

1.) Further information in chapter "3. Circuit functions" on page 6

Further versions on request	
Approval Food processing, drinking water, oxygen, fuel gases, explosion protection	Pressure Other versions for operating pressures up to 25 bar(g) Vacuum version down to -0.9 bar(g)
Material Seal: NBR, FKM, EPDM	Temperature High temperature version up to 230 °C Hot water version up to 200 °C Low temperature version down to -40 °C
Process connection Clamp connection, welded connection	

10.4. Ordering chart welded connection

Valve with flow direction below seat

Control function	Nominal diameter	Actuator size Ø	Port connection Pipe - Ø	Pilot pressure min.	Operating pressure max.	Article no.	
	NPS	[mm]	[mm]	[bar(g)]	[bar(g)]	PA actuator	PPS actuator
EN ISO 1127 / ISO 4200							
CF: A, see control functions ^{1.)}	15	50(D)	21.3 × 1.6	4.1	16	344388	344473
	20	50(D)	26.9 × 1.6	4.1	11	344389	344474
	25	63(E)	33.7 × 2.0	4.5	11	344390	344475
	32	80(F)	42.4 × 2.0	5	14	344391	344450
	40	80(F)	48.3 × 2.0	5	9	344392	344483
	50	100(G)	60.3 × 2.0	4.4	7.2	345012	356461
	65	125(H)	76.1 × 2.3	3.2	5.2	344588	On request
			76.1 × 2.3	5.7	12	20001505	On request
CF: B, see control functions ^{1.)}	15	50(D)	21.3 × 1.6	See diagrams ^{2.)}	16	345485	344478
	20	50(D)	26.9 × 1.6		16	344405	344479
	25	63(E)	33.7 × 2.0		25	344406	On request
	32	63(E)	42.4 × 2.0		25	344407	On request
	40	63(E)	48.3 × 2.0		25	344408	353580
	50	63(E)	60.3 × 2.0		13	345013	On request
	65	80(F)	76.1 × 2.3		15	344609	On request
DIN 11850 2							
CF: A, see control functions ^{1.)}	15	50(D)	19 × 1.5	4.1	16	344267	344557
	20	50(D)	23 × 1.5	4.1	11	344522	344559
	25	63(E)	29 × 1.5	4.5	11	344523	344540
	32	80(F)	35 × 1.5	5	14	344524	352462
	40	80(F)	41 × 1.5	5	9	344525	352468
	50	100(G)	53 × 1.5	4.4	7.2	344526	352467
	65	125(H)	70 × 2.0	3.2	5.2	344614	On request
			70 × 2.0	5.7	12	20015086	On request
CF: B, see control functions ^{1.)}	15	50(D)	19 × 1.5	See diagrams ^{2.)}	16	344527	352208
	20	50(D)	23 × 1.5		16	344528	344558
	25	63(E)	29 × 1.5		25	344530	366314
	32	63(E)	35 × 1.5		25	344531	352385
	40	63(E)	41 × 1.5		25	344532	352387
	50	63(E)	53 × 1.5		13	344533	154903
	65	80(F)	70 × 2.0		15	344617	On request
ASME BPE							
CF: A, see control functions ^{1.)}	½	50(D)	12.7 × 1.65	4.1	16	344549	344547
	¾	50(D)	19.05 × 1.65	4.1	11	344726	On request
	1	63(E)	25.4 × 1.65	4.5	11	345476	344879
	1½	80(F)	38.1 × 1.65	5	9	344553	On request
	2	100(G)	50.8 × 1.65	4.4	7.2	344727	On request
CF: B, see control functions ^{1.)}	½	50(D)	12.7 × 1.65	See diagrams ^{2.)}	16	344550	364483
	¾	50(D)	19.05 × 1.65		16	344583	On request
	1	63(E)	25.4 × 1.65		25	183280	On request
	1½	63(E)	38.1 × 1.65		25	344554	On request
	2	63(E)	50.8 × 1.65		13	344630	On request

1.) Further information in chapter "3. Circuit functions" on page 6

2.) See diagrams in chapter "Pilot pressure diagram with flow direction below seat (control function B, seat seal PTFE)" on page 13





Valve with flow direction above seat

The following tables refer to valves with stainless steel body, an actuator material of PA and Ra inside from $\leq 3.2 \mu\text{m}$

Control function	Nominal diameter	Actuator size \varnothing	Port connection Pipe - \varnothing	Pilot pressure min.	Operating pressure max.	Article no.	
	NPS	[mm]	[mm]	[bar(g)]	[bar(g)]	PA actuator	PPS actuator
EN ISO 1127 / ISO 4200							
CF: A, see control functions ^{1.)}	15	50(D)	21.3 × 1.6	See diagrams ^{2.)}	16	344402	352370
	20	50(D)	26.9 × 1.6		16	344401	On request
	25	63(E)	33.7 × 2		16	344400	352457
	32	63(E)	42.4 × 2		16	344397	On request
	40	63(E)	48.3 × 2		16	344398	344480
	50	63(E)	60.3 × 2.0		16	345014	On request
	65	80(F)	76.1 × 2.3		14	345146	On request
DIN 11850 2							
CF: A, see control functions ^{1.)}	15	50(D)	19 × 1.5	See diagrams ^{2.)}	16	342493	344582
	20	50(D)	23 × 1.5		16	344534	344863
	25	63(E)	29 × 1.5		16	344535	352203
	32	63(E)	35 × 1.5		16	344536	352390
	40	63(E)	41 × 1.5		16	344537	352207
	50	63(E)	53 × 1.5		16	341778	352461
	65	80(F)	70 × 2.0		14	344625	367783
ASME BPE							
CF: A, see control functions ^{1.)}	½	50(D)	12.7 × 1.65	See diagrams ^{2.)}	16	344728	On request
	¾	50(D)	19.05 × 1.65		16	344729	On request
	1	63(E)	25.4 × 1.65		16	344730	344556
	1½	63(E)	38.1 × 1.65		16	344731	On request
	2	63(E)	50.8 × 1.65		16	344602	On request

1.) Further information in chapter "3. Circuit functions" on page 6

2.) See diagrams in chapter "Pilot pressure diagram with flow direction above seat (control function A, seat seal PTFE)" on page 15

Further versions on request	
 Approval Food processing, drinking water, oxygen, fuel gases, explosion protection	 Pressure Other versions for operating pressures up to 25 bar(g) Vacuum version down to -0.9 bar(g)
 Material Seal: NBR, FKM, EPDM	 Temperature High temperature version up to 230 °C Hot water version up to 200 °C Low temperature version down to -40 °C
 Process connection Clamp connection, threaded connection	

10.5. Ordering chart clamp connection

Valve with flow direction below seat

Note:

The following tables refer to valves with stainless steel body

Control function	Nominal diameter	Actuator size Ø	Port connection, external Ø	Pilot pressure min.	Operating pressure max.	Article no.	
	DN	[mm]	[mm]	[bar(g)]	[bar(g)]	PA actuator	PPS actuator
ISO 2852							
CF: A, see control functions ^{1.)}	15	50(D)	34.0	4.1	16	345128 ☒	On request
	20	50(D)	50.5	4.1	11	345129 ☒	On request
	25	63(E)	50.5	4.2	11	345130 ☒	344574 ☒
	32	80(F)	50.5	5	14	345131 ☒	On request
	40	80(F)	64.0	5	9	345132 ☒	On request
	50	100(G)	77.5	4.4	7.2	345133 ☒	On request
CF: B, see control functions ^{1.)}	15	50(D)	34.0	See diagrams ^{2.)}	16	363929 ☒	On request
	20	50(D)	50.5		16	345134 ☒	On request
	25	50(D)	50.5		16	363930 ☒	On request
	32	63(E)	50.5		16	363933 ☒	On request
	40	63(E)	64.0		16	363940 ☒	On request
	50	63(E)	77.5		13	363942 ☒	On request
ASME BPE							
CF: A, see control functions ^{1.)}	½	50(D)	25.0	4.1	16	344632 ☒	On request
	¾	50(D)	25.0	4.1	11	344633 ☒	On request
	1	63(E)	50.5	4.2	11	344634 ☒	On request
	1½	80(F)	50.5	5	9	344635 ☒	On request
	2	100(G)	64.0	4.4	7.2	344636 ☒	On request
CF: B, see control functions ^{1.)}	½	50(D)	25.0	See diagrams ^{2.)}	16	On request	On request
	¾	50(D)	25.0		16	On request	On request
	1	50(D)	50.5		16	On request	On request
	1½	63(E)	50.5		16	On request	On request
	2	63(E)	64.0		13	On request	On request

1.) Further information in chapter "3. Circuit functions" on page 6





2.) See diagrams in chapter "Pilot pressure diagram with flow direction below seat (control function B, seat seal PTFE)" on page 13

Valve with flow direction above seat

Control function	Nominal diameter	Actuator size Ø	Port connection, external Ø	Pilot pressure min.	Operating pressure max.	Article no.	
	DN	[mm]	[mm]	[bar(g)]	[bar(g)]	PA actuator	PPS actuator
ISO 2852							
CF: A, see control functions ^{1.)}	15	50(D)	34.0	See diagrams ^{2.)}	16	345135	345145
	20	50(D)	50.5		16	345136	On request
	25	63(E)	50.5		16	345137	On request
	32	63(E)	50.5		16	345138	On request
	40	63(E)	64.0		16	345139	On request
	50	63(E)	77.5		16	345140	431027
ASME BPE							
CF: A, see control functions ^{1.)}	1/2	50(D)	25.0	See diagrams ^{2.)}	16	344721	On request
	3/4	50(D)	25.0		16	344722	On request
	1	63(E)	50.5		16	344723	On request
	1 1/2	63(E)	50.5		16	344724	On request
	2	63(E)	64.0		16	344725	On request

1.) Further information in chapter "3. Circuit functions" on page 6

2.) See diagrams in chapter "Pilot pressure diagram with flow direction above seat (control function A, seat seal PTFE)" on page 15

Further versions on request	
 Approval Food processing, drinking water, oxygen, fuel gases, explosion protection	 Pressure Other versions for operating pressures up to 25 bar(g) Vacuum version down to -0.9 bar(g)
 Material Seal: NBR, FKM, EPDM	 Temperature High temperature version up to 230 °C Hot water version up to 200 °C Low temperature version down to -40 °C
 Process connection Clamp connection acc. to DIN 32676, welded connection, threaded connection	

10.6. Ordering chart accessories

Accessories for 3/2-way pilot valves with banjo bolts

Note:

- Seal material FKM / NBR
- Complete program see data sheet [7012](#) ▶, [6014](#) ▶, [2507](#) ▶, [2518](#) ▶

Valves for actuator size Ø	Type	Pilot air port	Working port (banjo bolt)	Q _{Nn} value air	Pressure range	Electrical coil connection Ind. Std.	Power consumption	Article no.			
								Voltage/Frequency		Cable plug	
								024 V/DC	230 V/50	12...24 AC/DC with LED	0...250 AC/DC
[mm]				[l/min]	[bar(g)]		[W]	[V]	[V]	[V]	[V]
40(C)	7012	Thread G ¼	Thread G ⅝	48	0...10	Type 2507 Form B	4	390831	390835	423849	423845
		Push-in connector Ø6 mm						390880	390887		
50(D)...63(E)	7012	Thread G ¼	Thread G ¼	48	0...10	Type 2507 Form B	4	390850	390854	423849	423845
		Push-in connector Ø6 mm						390905	390911		
50(D)...125(H)	6014P	Thread G ¼	Thread G ¼	120	0...10	Type 2518 Form A	8	334870	389550	314812	314802

Bürkert – Close to You

For up-to-date addresses
please visit us at
www.burkert.com

DTS 1000444947 EN Version: R Status: RL (released | freigegeben | validé) printed: 09.03.2023



Product Enquiry Form - Pneumatic Shut-off Valves

Thank you for your interest in our products! In order to provide you with optimum advice, please fill out the following form and send it to your **Bürkert representative** or E-mail address: info@burkert.com. All information submitted will of course be kept strictly confidential.

Please fill in the required fields! *

*Note: The interactive functions of this PDF may be restricted depending on the PDF reader used.

Personal Information			
Company		Contact person	
Customer no.		Department	
Street		Postcode / Town	
Telephone no.		E-mail	

Delivery	
Quantity	Required delivery date

Operating data			
Function <small>(Function of the control valve in the process / process description)</small>			
Pipeline	DN	PN	
Operating medium			
Type of medium	Fluid	Steam	Gas
Operating pressure	Unit		
Medium temperature	°C / °F		
Ambient temperature	°C / °F		

Valve body				
Construction	Angle seat valve		Globe valve	
Actuator material	Stainless steel/PPS		Stainless steel	PPS PA
Housing material	Stainless steel		Gunmetal	
Seat seal	PTFE EPDM		NBR Other	PEEK FKM
DN / Nominal pressure	DN		PN	
Flow coefficient	K_v	m^3/h	C_v	GPM(US)
Connection	Flange	DIN EN 1092-1		ANSI B16.5 JIS 10K
	Thread	G		NPT RC
	Weld	DIN EN ISO 1127 / ISO 4200		DIN 11850 2 / DIN 11866 A ASME BPE
	Clamp	ASME BPE		DIN 32676 A (tube ISO 4200) DIN 32676 B (tube DIN 11850)
	Other			

Valve data	
Circuit Function	A: Normally closed B: Normally open I: Double acting
Control pressure	Min. Max.

DTS 1000444947 EN Version: R Status: RL (released | freigegeben | valide) printed: 09.03.2023

Approvals / Conformities

For use with food (conform to EG regulation no. 1935/2004)
For use with food (conform to FDA)
Explosion protection in accordance with ATEX II 2GD mech. / IECex
European Gas Appliances Directive (EU) 2016/426, DVGW DIN EN 161 and DIN EN 16678
Suitable for drinking water ^{1.)}
Certificate for the fulfilment of the order EN-ISO 10204 2.1 (Article no. 440788)
Test report EN-ISO 10204 2.2 (Article no. 803722)
Conformity certification for raw material EN-ISO 10204 3.1 (included)

1.) For use with drinking water for medium temperatures up to 85 °C in accordance with the Drinking Water Ordinance §17 and the assessment principles of the Federal Environment Agency.

Additional Requirements / Comment

DTS 1000444947 EN Version: R Status: RL (released | freigegeben | valide) printed: 09.03.2023

Control heads / pneumatic control for on/off process valves of the CLASSIC series

For actuator size ø40 to 225 mm

Electrical position feedback Type 8697 ▶



- Optical position indicator
- Mechanical or inductive limit switches for end position registering
- Optional intrinsically safe version acc. to ATEX / IECEx

Electrical connection

Cable gland

M12 connector^{1.)}

Number of end position feedback switches

2x Micro or inductive

Approvals

ATEX cat. 3GD, IECEx

ATEX cat. 2DG, IECEx

Without

Position feedback switch

Micro switch 24 V DC

Micro switch 50...225 V DC/AC

Inductive switch 3-wire PNP

Inductive switch 2-wire NAMUR

Inductive switch 2-wire 24 V DC

Without

1.) Applicable only with inductive switch 3-wire PNP